



ICOM

VHF FM TRANSCEIVER

IC-H16T

SELECTIVE CALLING WITH 5-TONE CAPABILITY

OWNER'S MANUAL



FOREWORD

Thank you for choosing the ICOM IC-H16T, one of the most advanced VHF portables equipped with a 5-Tone function on the Land Mobile market today.

Utilizing sophisticated computer based technology and ICOM's precision VHF engineering, the IC-H16T incorporates state-of-the-art design concepts to meet the demanding needs and requirements of the Land Mobile user.

UNPACKING

Accessories included with the IC-H16T:

	QTY.
① Flexible antenna	1
② Handstrap	1
③ Belt clip screws	2
④ Belt clip plastic washers	2
⑤ Belt clip	1
⑥ External speaker plug.	1
⑦ External microphone plug	1
⑧ External DC power plug	1
⑨ Earphone.	1
⑩ Rainproof cap.	1

The following accessories are also included with some versions:

⑪ IC-CM8 BATTERY PACK	1
⑫ WALL CHARGER (CM-16E or CM-17).	1

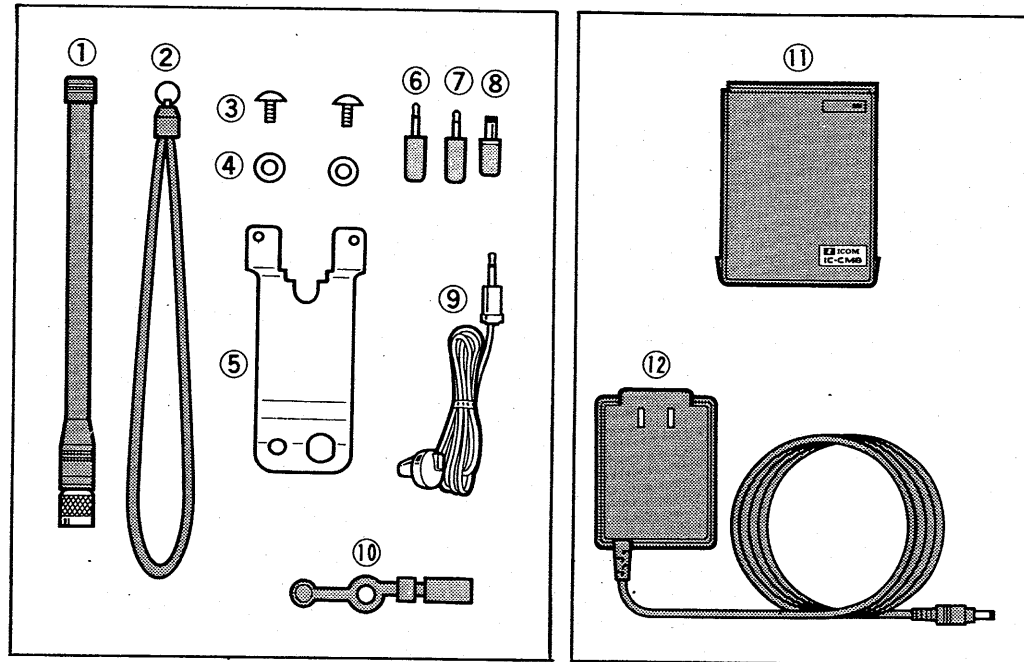

The above accessories are included with some versions.

TABLE OF CONTENTS

SECTION	1	FEATURES.....	1
SECTION	2	PRE-OPERATION.....	2
SECTION	3	CONTROL FUNCTIONS.....	5
SECTION	4	GENERAL OPERATIONS.....	11
	4-1	RECEIVING.....	11
	4-2	TRANSMITTING.....	13
	4-3	KEY FUNCTIONS.....	14
SECTION	5	FUNCTION OPERATIONS.....	15
	5-1	CHANNEL SELECTING.....	15
	5-2	GROUP CALL SELECTING.....	16
	5-3	5-TONE CODE SELECTION.....	17
	5-4	SCANNING.....	18
	5-5	CHANNEL LOCKOUT.....	19
	5-6	KEYBOARD LOCK FUNCTION.....	20
	5-7	BEEP TONE FUNCTION.....	20
	5-8	SPECIAL FEATURES.....	21
SECTION	6	SPECIFICATIONS.....	22
SECTION	7	MAINTENANCE.....	23
SECTION	8	OPTIONS.....	24

SECTION 1 FEATURES

- Employs an onboard, high-technology microcomputer to provide a tremendous number of features for complete flexibility.
- 16 channels with programmable frequency, semi-duplex, 5-Tone codes, subaudible tone encoder capability, and more.
- Constructed with an all-metal chassis and a reinforced die-cast aluminum back for use in demanding environments.
- Equipped with an alarm function that is activated when the transceiver receives an individual programmable code.
- Lockout scan function that skips specific channels in the scanning sequence.
- 5-Tone code function that separately receives, transmits, and answers back for personal, customized communications.
- Accepts a variety of battery packs that easily slide on and off the transceiver.
- The **IC-H16T** is splash resistant when the belt clip screws and rainproof cap for the top panel are in place.

CHARGER CONNECTIONS

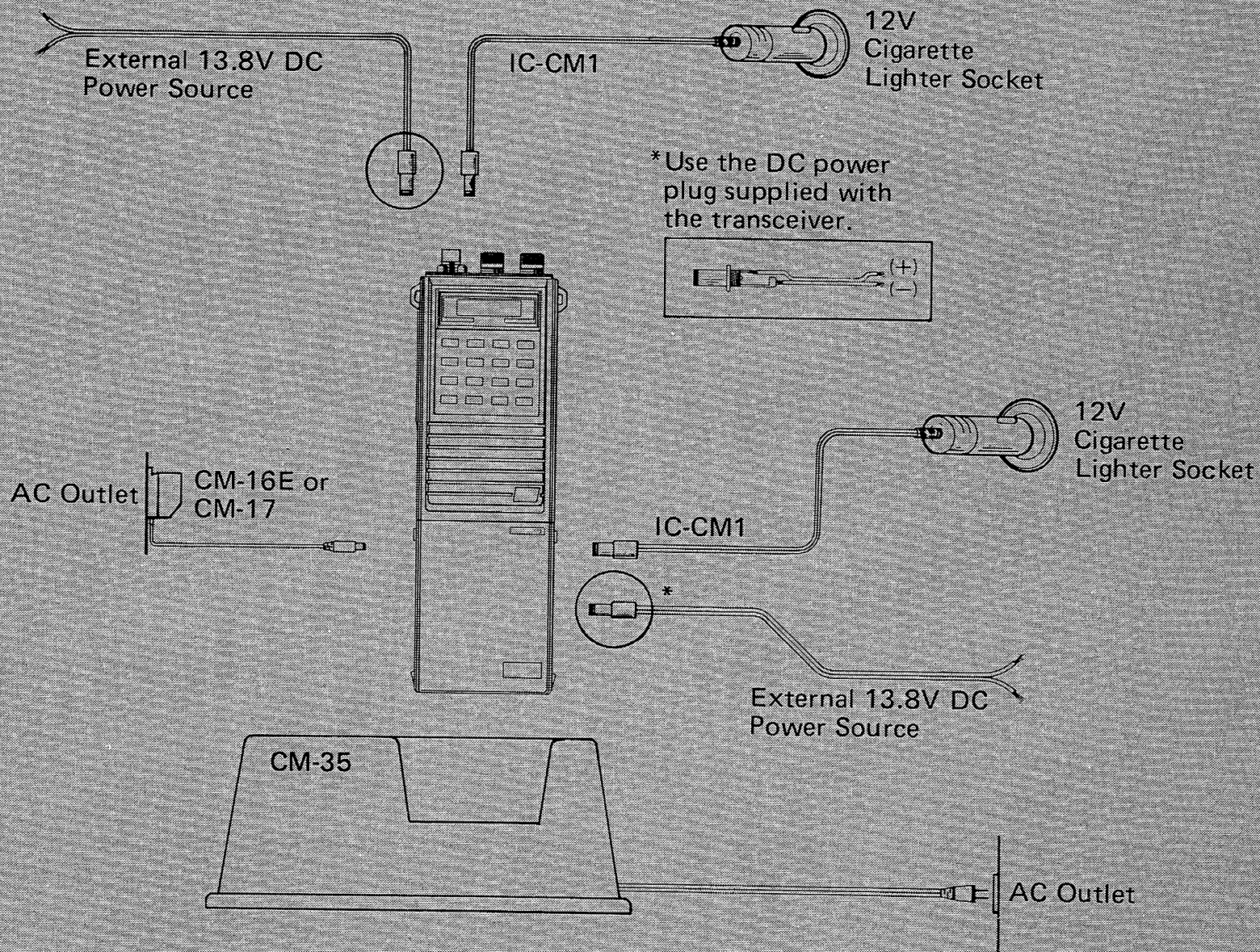

ANTENNA CONNECTION

Insert the connector on the flexible antenna into the antenna connector on the top of the transceiver. Screw down securely.

For mobile operation, contact your nearest dealer for a high-performance magnetic mount or clip-on antenna.

BELT CLIP INSTALLATION

Attach the belt clip to the back panel using the two supplied screws and plastic washers.

HAND STRAP ATTACHMENT

Spread open and slide the ring of the hand strap over either of the projecting loops on the sides of the transceiver.

ATTACHMENT OF BELT CLIP AND HAND STRAP

- Attach the belt clip on the back panel with 2 screws and plastic washers supplied.

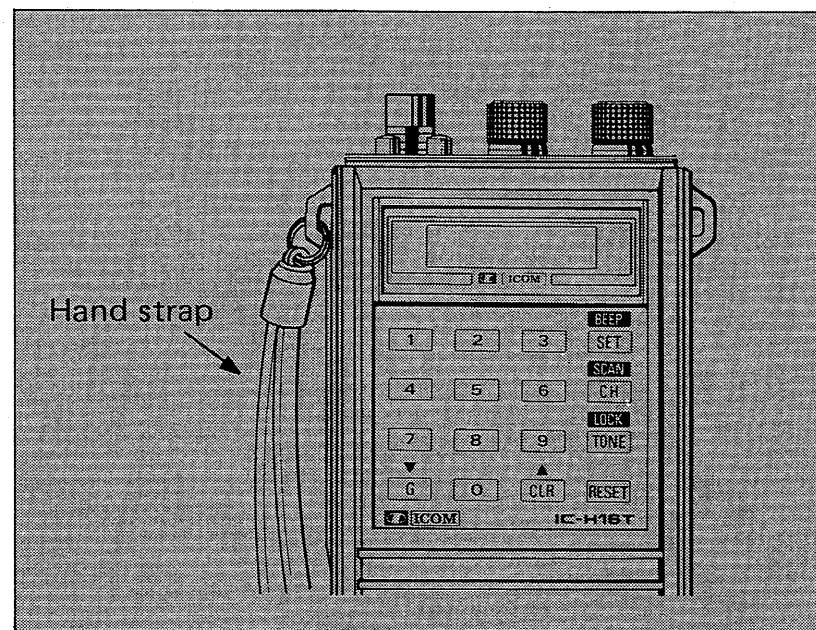
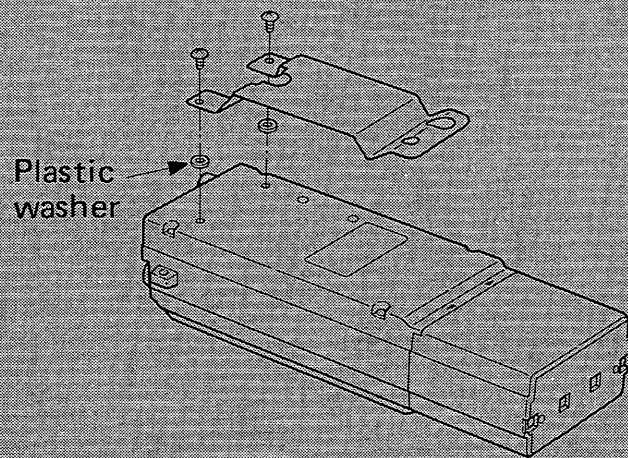

SECTION 3 CONTROL FUNCTIONS

TOP PANEL

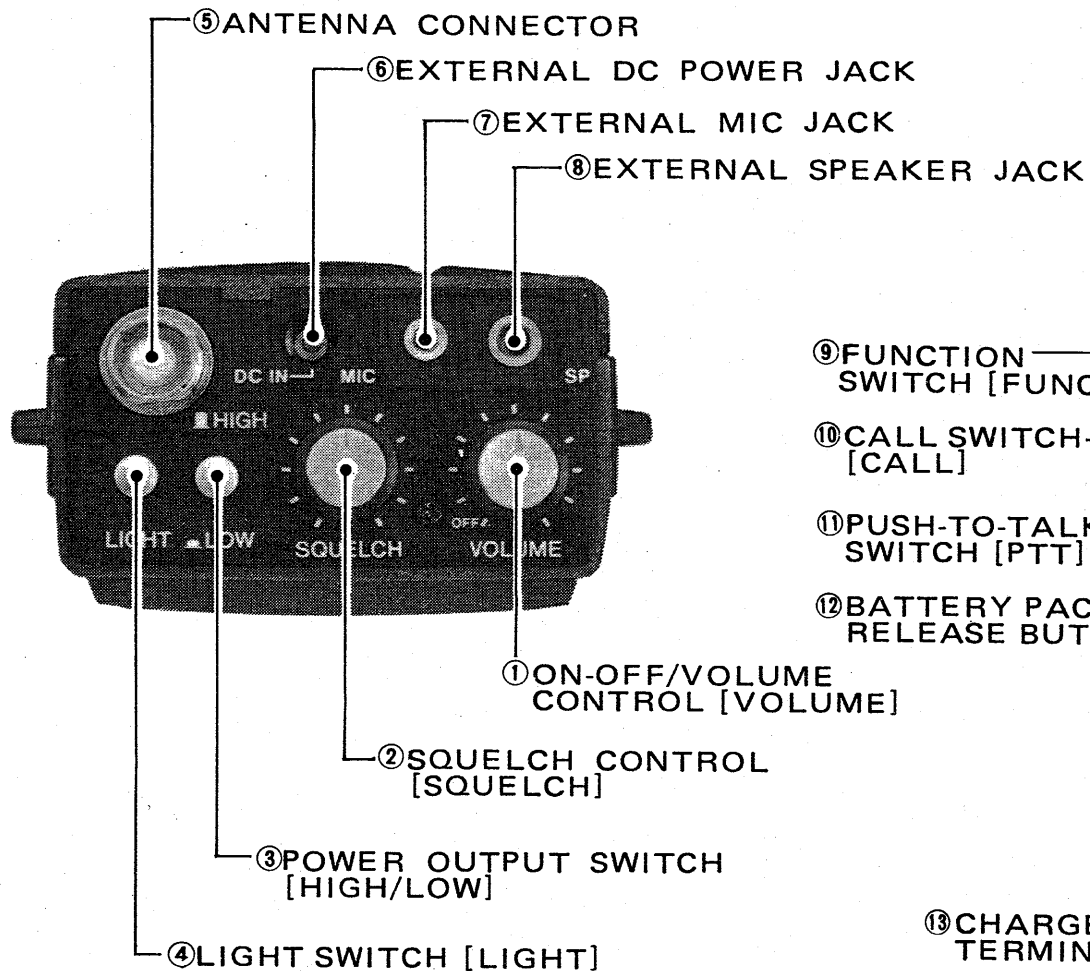

FRONT PANEL

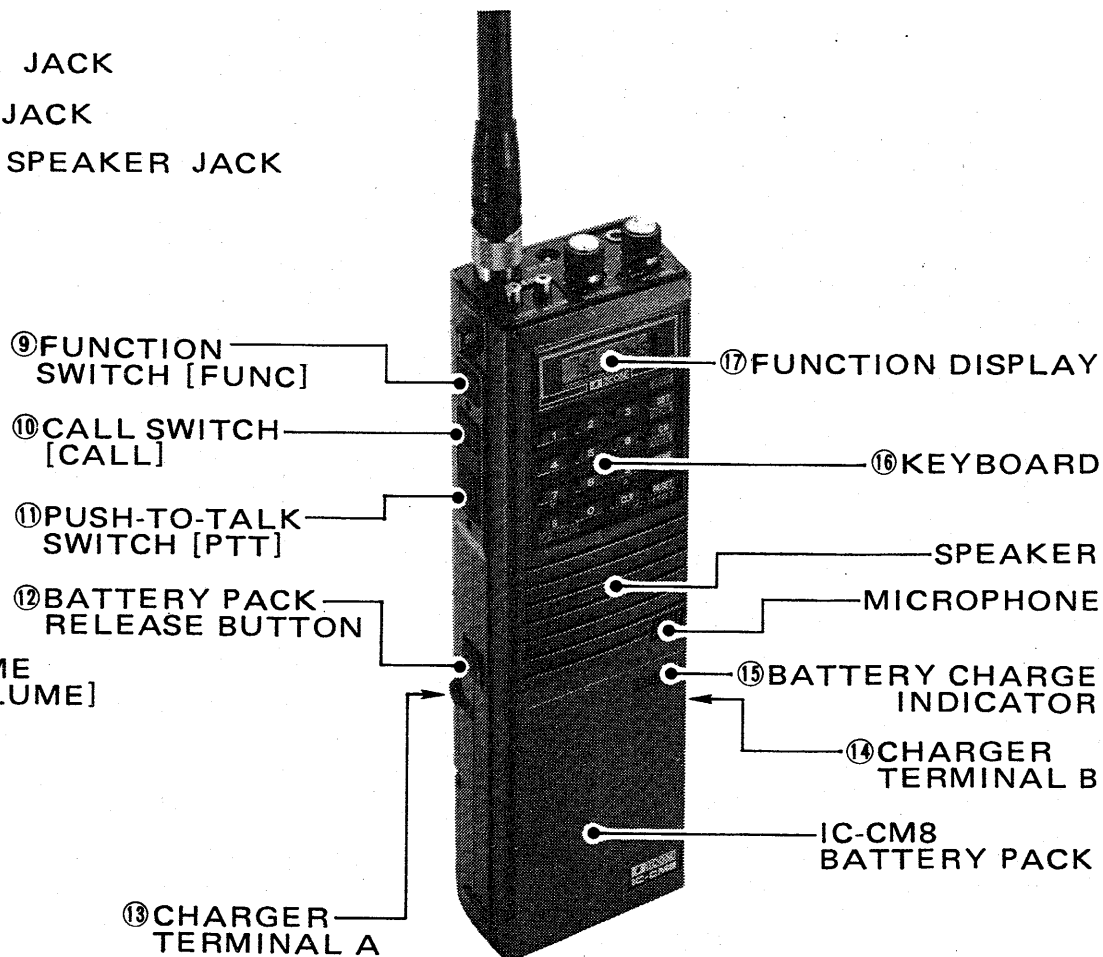

① **ON-OFF/VOLUME CONTROL**
[VOLUME]

Increases the
audio level.

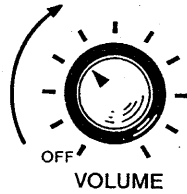

Rotate clockwise to turn the transceiver ON and increase the audio level.

② **SQUELCH CONTROL**
[SQUELCH]

Raises the
threshold
level.

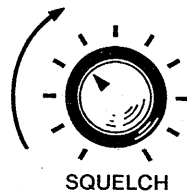

Sets the squelch threshold level. Rotate this control completely counterclockwise to turn OFF the squelch function, and clockwise to raise the threshold level.

③ **POWER OUTPUT SWITCH**
[HIGH/LOW]

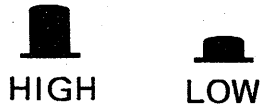

HIGH: Greater coverage for long distance transmissions.

LOW : Low output power conserving battery life.

④ **LIGHT SWITCH [LIGHT]**

Push this switch IN to turn ON the backlight for the FUNCTION DISPLAY.

⑤ ANTENNA CONNECTOR

Connect the supplied flexible antenna here.

CAUTION: Transmitting without an antenna may damage the transceiver.

⑥ EXTERNAL DC POWER JACK

Connect the IC-CM1 CIGARETTE LIGHTER CABLE or external 13.8V DC power source to this jack for mobile operation. The battery pack does not need to be installed to operate the transceiver. However, if the battery pack is installed, it charges simultaneously. See page 3.

⑦ EXTERNAL MIC JACK

The optional IC-CM9 SPEAKER-MICROPHONE, optional HS-10 HEADSET or the optional HS-15 BOOM MIC can be connected for additional flexibility. (The HS-10 and HS-15 require the HS-10SA VOX UNIT or the HS-10SB PTT SWITCH BOX.) The built-in microphone is not functional when an external microphone is connected.

⑧ EXTERNAL SPEAKER JACK

Connect either an 8Ω external speaker or the supplied earphone for private listening.

⑨ FUNCTION SWITCH [FUNC]

Push this switch to select the secondary function of each key. See page 14.

- ⑩ **CALL SWITCH [CALL]** Push this switch to transmit a 5-Tone code.
- ⑪ **PUSH-TO-TALK SWITCH [PTT]** Push this switch to begin transmitting.
- ⑫ **BATTERY PACK RELEASE BUTTON** Push the release button upwards, and slide the battery pack to the right to remove it from the transceiver.
- ⑬ **CHARGER TERMINAL A** Connect the output plug from the CM-16E or CM-17 WALL CHARGER here for battery charging. See page 3.
- ⑭ **CHARGER TERMINAL B** Connect the external 13.8V DC power source here for battery charging. See page 3.
- ⑮ **BATTERY CHARGE INDICATOR** Lights up while a battery pack is charging except when the optional CM-35 or CM-36 AC BATTERY CHARGER is being used.
- ⑯ **KEYBOARD**

The KEYBOARD has 16 keys consisting of ten numerical keys and six code keys. Some keys have dual functions. See page 14 for details.

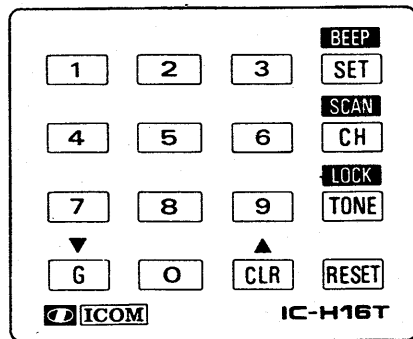

⑰ FUNCTION DISPLAY

The FUNCTION DISPLAY shows the operating channel, a 5-Tone code, and other functions as described below.

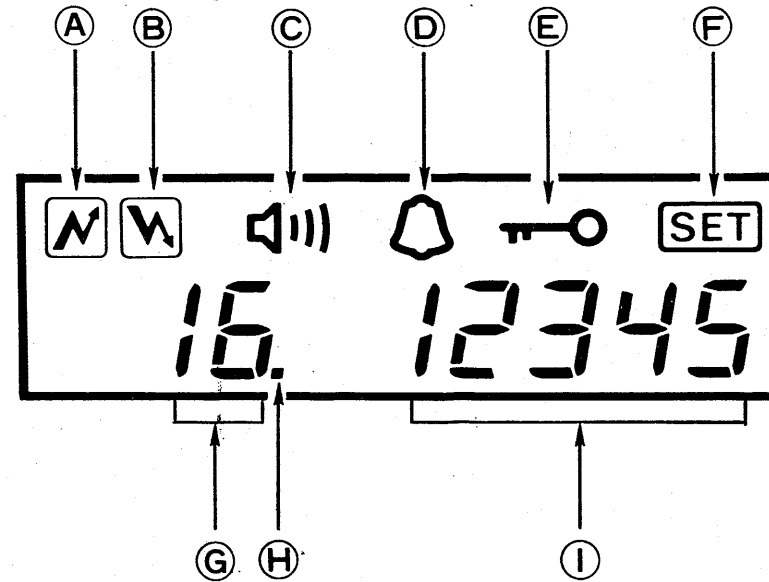

① TRANSMIT INDICATOR

"**N**" appears when the transceiver is in the transmit mode.

② BUSY INDICATOR

"**W**" appears when the transceiver is in the receive mode.

MONITOR FUNCTION:

The transceiver acknowledges only a signal which has the same 5-Tone code as pre-programmed (an individual code) in the transceiver. However, the transceiver accepts any 5-Tone signal when the monitor function is activated.

Ⓒ MONITOR INDICATOR

"" appears when the monitor function is turned ON. See page 11 for more information.

Ⓓ CALL INDICATOR

"" appears when an individual code is received. See page 12 for more information.

Ⓔ LOCK INDICATOR

"" appears when the keyboard has been deactivated to prevent unwanted key entry. See page 20.

Ⓕ SET MODE INDICATOR

"" appears when the transceiver is in the SET MODE to program the lockout channels. See page 19.

Ⓖ CHANNEL INDICATOR

Displays the operating channel number.

Ⓗ SCAN CHANNEL INDICATOR

"" appears when a channel is not locked out and disappears when a channel is locked out.

Ⓘ 5-TONE CODE INDICATOR

Displays the transmit 5-Tone code. See page 17.

SECTION 4 GENERAL OPERATIONS

4 - 1 RECEIVING

1) Turn ON power.

2) Push [RESET] KEY.

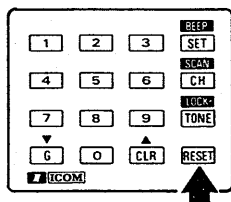

3) Adjust [VOLUME] CONTROL.

4) Adjust [SQUELCH] CONTROL.

1) Rotate the [VOLUME] CONTROL clockwise.

- The channel number and 5-Tone code appear on the FUNCTION DISPLAY.

2) Push the [RESET] KEY to switch ON the monitor function.

- “” appears on the FUNCTION DISPLAY.
- See page 10 for explanation of the monitor function.

3) Adjust the [VOLUME] CONTROL clockwise to a comfortable listening level after rotating the [SQUELCH] CONTROL fully counterclockwise.

4) Rotate the [SQUELCH] CONTROL clockwise until the noise is quieted. This is the threshold point where signals can be received.

SQUELCH: If closed, the squelch mutes all noise from the speaker when no signal is received. This is useful while waiting for another station to call.

5) Push [RESET] KEY.

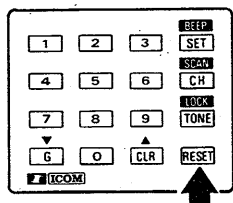

6) Receives an **individual code**.

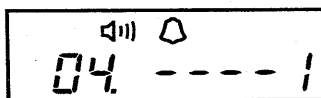



7) Receives **group call**.

8) Push [RESET] KEY.



5) Push the [RESET] KEY again to turn OFF the monitor function.

- “” disappears from the FUNCTION DISPLAY.

6) When the IC-H16T receives an **individual code**, the transceiver may be activated as follows depending on the pre-programming and individual code:

- “” appears on the FUNCTION DISPLAY.
- An ALARM sound (one beep tone or a repetition of beep tones) is emitted.
- An answer back code is transmitted.
- The last digit of the calling station’s 5-Tone code is displayed.
- The monitor function is ON, and “” appears.

7) When the IC-H16T receives a **group call** code, the transceiver may be activated as follows:

- “” appears on the FUNCTION DISPLAY.
- ALARM sounds (a repetition of beep tones) are emitted.
- The monitor function is ON, and “” appears.

8) After finishing your communication, push the [RESET] KEY again and wait for the next call.

4 - 2 TRANSMITTING

1) Select a 5-Tone code.

2) Push [CALL] SWITCH.

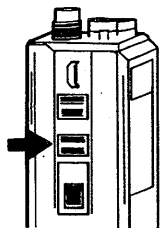

3) Push [PTT] SWITCH.

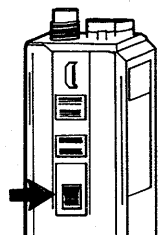

4) Release [PTT] SWITCH.

To avoid damage the antenna must be connected to the IC-H16T.

1) Select the pre-programmed 5-Tone code by using digit keys "0" ~ "9".

2) Push the [CALL] SWITCH to transmit a 5-Tone code.

3) Push the [PTT] SWITCH to begin transmitting. Speak into the microphone using your normal voice level.

"" appears on the FUNCTION DISPLAY during transmission.

4) Release the [PTT] SWITCH to return to receiving.

CAUTION: DO NOT transmit while "" appears as your transmission may interfere with other radio communications.

4 - 3 KEY FUNCTIONS

Some keys have dual functions. To select the secondary function, push and hold the [FUNC] SWITCH, and then push the correct key for the function desired.

KEY	PRIMARY FUNCTION	SECONDARY FUNCTION (Hold down [FUNC])
0 ~ 9	Selects a 5-Tone code, if pre-programmed. Inputs each number after pushing the [CLR], [CH], or [TONE] KEY.	The same as the primary function even when the lock function is activated. (p. 20)
▼ G	Inputs the group call code after pushing the [CLR] KEY. (p. 16)	Decreases the operating channel number. (p. 15)
▲ CLR	Clears the last digit of the 5-Tone code. (p. 17)	Increases the operating channel number. (p. 15)
BEEP SET	Selects the lockout scan channel. (p. 19)	Turns ON and OFF a beep tone that sounds each time any key is pushed. (p. 20)
SCAN CH	Clears the channel number to input a new number. (p. 15)	Starts the scan function when "🔊" does not appear. (p. 18)
LOCK TONE	Clears a 5-Tone code to input a new code. (p. 17)	Turns ON and OFF the lock function to prevent accidental key entries. (p. 20)
RESET	Turns ON and OFF the monitor function. (p. 11) Returns transceiver to the normal operating mode. (p. 19)	The same as the primary function even when the lock function is activated. (p. 20)

SECTION 5 FUNCTION OPERATIONS

5 - 1 CHANNEL SELECTING

The operating channel can be selected by using the digit keys, the [▲] KEY or [▼] KEY if more than two channels are pre-programmed.

1) Push the [CH] KEY and then select the desired channel by using the digit keys.

- If a non-programmed channel is keyed in, this input is rejected and the display automatically reverts back to the previous channel.

2) Also, by using the [▲] KEY or [▼] KEY, the operating channel is changed upward or downward when the [FUNC] SWITCH is simultaneously pushed.

(CH SET) EXAMPLE:

Selecting channel 2.

Push keys

CH

0

2

Display

01 542 10

-- 542 10

0- 542 10

02 542 10

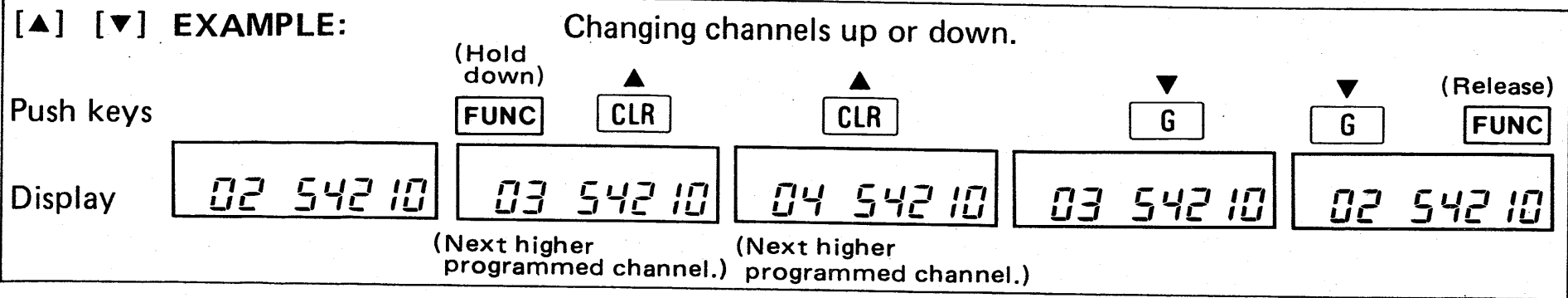

5 - 2 GROUP CALL SELECTING

GROUP CALL:

Group call selecting allows you to call several stations at the same time which have the same operating channels and same first digits (1 ~ 4) in a receive 5-Tone code pre-programmed by your ICOM Service Center (not the same as the displayed 5-Tone number).

- 1) Push the [CLR] KEY one or two times depending on your required group call.
- 2) Push the [G] KEY the same number of times as the [CLR] KEY.
- 3) Transmit the group call code by pushing the [CALL] SWITCH.

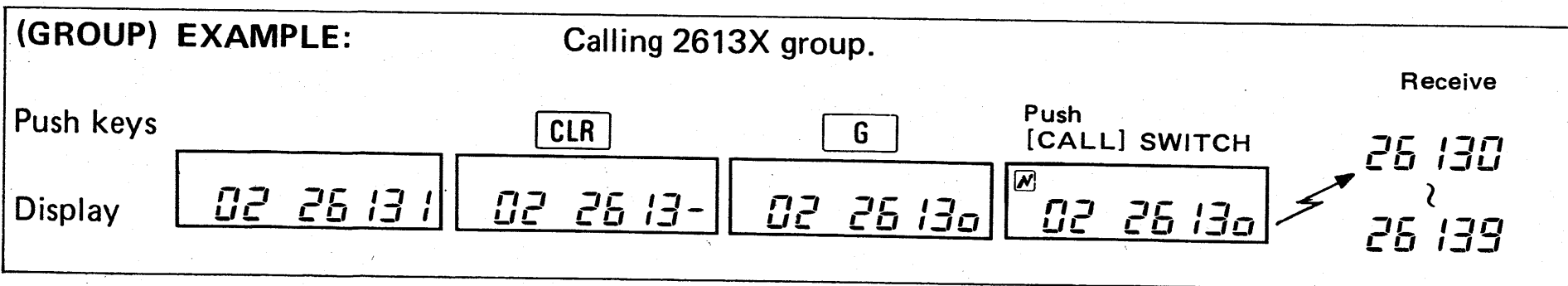

5 - 3 5-TONE CODE SELECTION

- 1) Push the [TONE] KEY. A 5-Tone code disappears.
- 2) Enter the desired 5-Tone code by using the digit keys.
- 3) When changing the last few digits, push the [CLR] KEY a few times and enter the new number.

[TONE] EXAMPLE 1: Entering 5-Tone code 23456.

Push keys		[TONE]	[2]	[3]	[4]	[5]	[6]
Display	02 26131	02 -----	02 2-----	02 234--	02 23456		

[TONE] EXAMPLE 2: Changing a 5-Tone code from 12158 to 12160.

Push keys		[CLR]	[CLR]	[6]	[0]
Display	02 12158	02 1215-	02 121--	02 1216-	02 12160

5 - 4 SCANNING

SCAN FUNCTION:

The IC-H16T is equipped with a scan function for sampling each of the pre-programmed channels. When receives an individual code, the scan will stop to monitor the received channel.

1) Push the [RESET] KEY to turn OFF the monitor function.

- “” disappears from the FUNCTION DISPLAY.

2) Push and hold the [FUNC] SWITCH, and then push the [SCAN] KEY.

3) Scanning begins from the displayed channel, and moves downwards.

4) Push the [RESET] KEY to stop the scanning.

- Pushing the [PTT] SWITCH or repeating step 2), also stops the scan.
- Scanning will turn OFF when the transceiver receives an individual code.

[SCAN] EXAMPLE:

Scanning the pre-programmed channels.

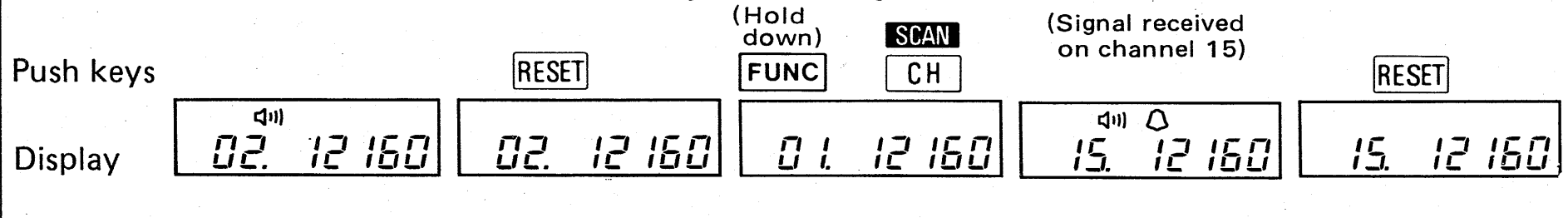

5 - 5 CHANNEL LOCKOUT

This function allows you to selectively choose which channels the scanning function will monitor.

- 1) Select the channel you wish to delete from or add to the scan channels. See page 15.
- 2) Push the [SET] KEY and then push the [1] KEY.
 - "S-ch on" or "S-ch oFF" appears on the FUNCTION DISPLAY.
- 3) Push the [SET] KEY to program or to clear the lockout channel alternately.
 - "S-ch on" : Monitors the displayed channel when the scan function is operating.
 - "S-ch oFF" : Skips the displayed channel when the scan function is operating.
- 4) Push the [RESET] KEY to return to the normal operating mode.
- 5) "■" appears to the right of the channel number on the FUNCTION DISPLAY if the channel is not locked out.

(LOCKOUT) EXAMPLE:

Setting lockout in channel 4.

Push keys

SET

1

SET

RESET

Display

04 12 160

04 12 160 SET

S-ch on SET

S-ch off SET

04 12 160

5 - 6 KEYBOARD LOCK FUNCTION

This feature prevents accidental changes of the operating channel or other functions selected from the KEYBOARD.

1) Push and hold the [FUNC] SWITCH, and then push the [LOCK] KEY to activate the lock function. "🔒" appears.

- The [RESET] KEY and digit keys can be used while pushing IN the [FUNC] SWITCH.

2) To clear the lock function, push and hold the [FUNC] SWITCH, and then push the [LOCK] KEY again.

5 - 7 BEEP TONE FUNCTION

When the beep tone function is ON, a beep sounds each time a key is pushed. The volume of the beep tone can be adjusted by turning the [VOLUME] CONTROL.

Push and hold the [FUNC] SWITCH and then push the [BEEP] KEY to turn the beep tone function ON and OFF alternately.

SECTION 6 SPECIFICATIONS

• GENERAL

Frequency range	:	136 ~ 174MHz (High and Low bands, 2 versions available)
Usable temperature range	:	-25°C ~ +60°C
Power supply requirement	:	7 ~ 16V DC (negative ground)
Current drain (with IC-CM8)	:	Receive Stand-by 70mA Audio max. 250mA Transmit High 1.3A Low 750mA
Dimensions (with IC-CM8)	:	65(74)mm(W) x 196(207)mm(H) x 38(41)mm(D) Bracketed values include projections.
Weight (with IC-CM8)	:	595g

• RECEIVER

Sensitivity	:	Less than 0.35 μ V for 12dB SINAD
Squelch sensitivity	:	Less than 0.4 μ V
Audio output power	:	More than 500mW at 10% distortion (with IC-CM8)
Audio output impedance	:	8 Ω

• TRANSMITTER

Output power	:	High 5W (with IC-CM7) 3W (with IC-CM8) Low 1W (with IC-CM7 or IC-CM8)
Emission mode	:	16K0F3E (Wide-type) 8K50F3E (Narrow-type)

SECTION 7 MAINTENANCE

Your transceiver was quality-engineered and manufactured to provide years of trouble-free operation in many different environments.

On an annual basis, it is recommended that your IC-H16T be given a routine technical checkout to ensure optimum operation. Contact your ICOM Dealer or authorized ICOM Service Center for this or any other required service.

RESETTING THE MICROPROCESSOR

If at any time your IC-H16T does not operate as described in this manual, turn the transceiver OFF and then ON again. This action resets the microprocessor in the transceiver and may eliminate your problem.

1) Rotate to OFF.



2) Rotate clockwise.

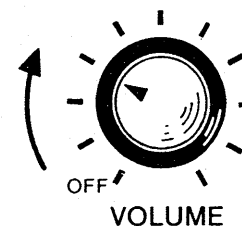

SECTION 8 OPTIONS

• MICROPHONE & HEADSET

IC-CM9 SPEAKER- MICROPHONE	Combination speaker and microphone.
HS-10 + HS-10SA HEADSET + VOX UNIT	Headset with VOX (voice controlled) T/R switching.
HS-10 + HS-10SB HEADSET + PTT SWITCH BOX	Headset with manual T/R switching.

• CHARGER & POWER CABLE

CM-35 CM-36 AC BATTERY CHARGER	Charges the battery pack in 1.5 ~ 3 or 15 hours (Charge times vary depending on each battery pack).
IC-CM1 CIGARETTE LIGHTER CABLE	For operation with a 12V-type cigarette lighter socket.
CP-10 BATTERY SEPARATION CABLE	Handy connector cable for separating the transceiver from the battery pack.

• BATTERY PACKS

	Voltage	Height	Capacity
IC-CM2	7.2V	39mm	425mAH
IC-CM3	8.4V	39mm	270mAH
IC-CM5	10.8V	60mm	425mAH
IC-CM5A	10.8V	80mm	425mAH
IC-CM7	13.2V	80mm	425mAH
IC-CM8	8.4V	80mm	800mAH
*IC-CM4	AA size x 6	49mm	--
*CM-12	AA size x 10	80mm	--

* Battery cases

• OTHERS

IC-MB16 MOBILE BRACKET IC-MB16D WALL BRACKET	For placing the IC-H16T in a convenient location.
SHOULDER STRAP	For transporting your IC-H16T.



ICOM

Your local agent:

ICOM INCORPORATED

1-6-19, KAMIKURATSUKURI, HIRANO-KU,
OSAKA 547, JAPAN

A-0860
Printed in Japan